



*An Online CPD Course  
brought to you by  
CEDengineering.ca*

## **Fundamentals of Modern Electrical Substations - Part 3**

Course No: E03-014  
Credit: 3 PDH

---

Boris Shvartsberg, Ph.D., P.E., P.M.P.

---



Continuing Education and Development, Inc.

P: (877) 322-5800  
[info@cedengineering.ca](mailto:info@cedengineering.ca)

## Introduction

Part 3 of the course “Fundamentals of Modern Electrical Substations” is concentrated on substation engineering aspects, which may be very challenging and require from utility companies engineers a very diverse knowledge and experience to address these aspects.

The following topics include a description of specific problems associated with them as well as possible resolution options:

- Reliability Analysis
- Typical Substation Switching Systems
- Insulation Coordination
- Substation Safety and Fire Protection
- Substation Design Issues
- Substation Insulator’s Performance Improvement

While this list of topics does not include all technical issues that substation engineers may encounter, it provides a good idea about their complexity and importance for effective operation of power systems.

## Reliability Analysis

As we discussed in Part 1 of this course, one of the main goals for every electrical utility company is to provide a high reliability of power supply to the customers. To accomplish this task, the company may invest in a power system infrastructure such as replacing the obsolete equipment, building additional power lines, etc. However, in order to select the most effective measures in reliability improvement, it is necessary to compare their effectiveness which explains the importance of reliability analysis.

Let’s familiarize ourselves with the basics of reliability theory which may be applied to any system, not only to power systems.

For a start, we need to discuss how to calculate the probability of failure for a single element of the system (for example, transformer, line, etc.). The following equation may be used to accomplish this:

$$p = \lambda r / 8,760 \quad (1)$$

Where:

p - probability of the element to be unavailable

$\lambda$  - rate of failure (in failures per year)

r - average downtime per failure (in hours per failure)

and 8,760 represents a number of hours in a calendar year.

Now, let's discuss a probability of failure for the system consisting of numerous elements, starting with a series system, shown in Fig. 1.

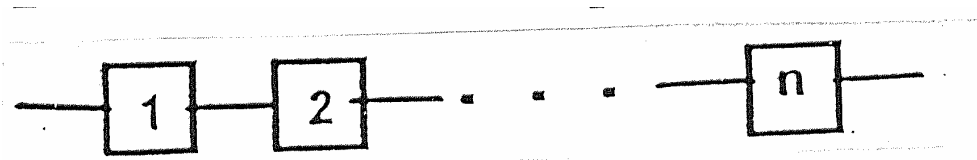

Fig. 1. System, Consisting of Elements Connected in Series

If a probability of failure for each element is  $p_1, p_2$ , etc., the probability of failure for the whole system may be found using the following equation:

$$P_{\Sigma} = p_1 + p_2 + \dots + p_n = \sum_{i=1}^n p_i$$

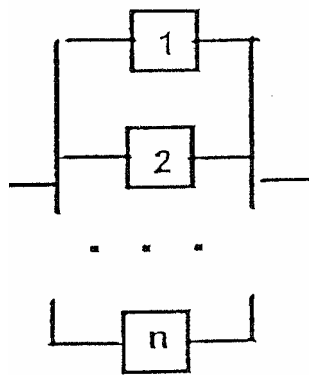

Fig. 2. System, Consisting of Elements Connected in Parallel

For a parallel system of elements, shown in Fig. 2, a similar equation for a probability of system failure may be written as follows:

$$P_{\Sigma} = p_1 \cdot p_2 \cdot \dots \cdot p_n = \prod_{i=1}^n p_i$$

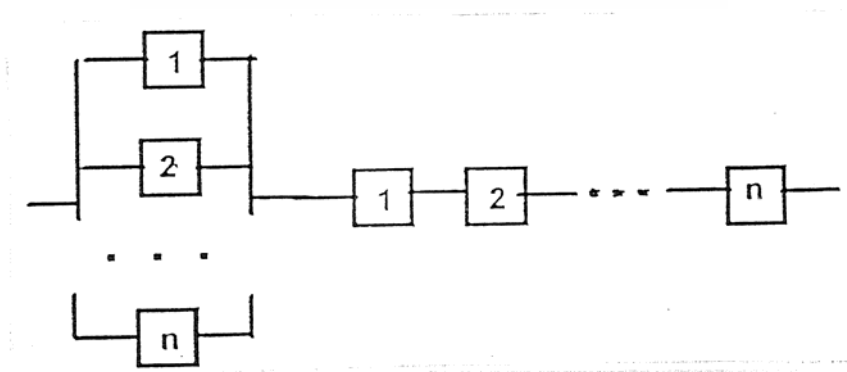

Fig. 3. System Consisting of Both Series and Parallel Elements

And finally, for a parallel-series system, shown in Fig. 3, the probability of system failure may be found from the following equation:

$$P_{\Sigma} = \prod_{i=1}^n P_i + \sum_{i=1}^n P_i$$

For a better understanding of reliability analysis, let's demonstrate it for the system, shown in Fig. 4.

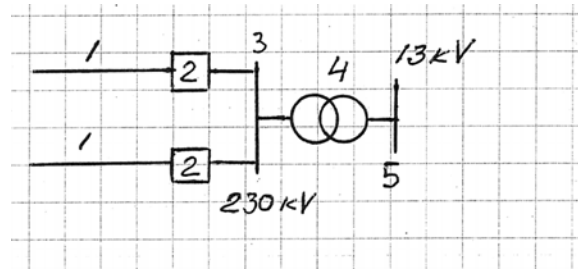

Fig. 4. Schematic of 230 – 13 kV Power System

The following reliability data is known for all system components:

	$\lambda$ , failures/year	r, hours
1 - 30 mi long 230 kV line	0.05/mi	10.00
2 - 230 kV circuit breaker	0.06	8.00
3 - 230 kV bus	0.01	16.00
4 - 230/13 kV transformer	0.012	80.00

Assuming that for 13 kV bus 5, we need to find an expected downtime per year  $D_f$  because of loss of power supply, let's start with the calculations of probability of equipment unavailability:

- $P_1 = 0.05 \text{ fail./mi} \times 30 \text{ mi} \times 10 \text{ hr} / 8760 \text{ hr} = 0.00171$
- $P_2 = 0.06 \text{ failures} \times 8 \text{ hr} / 8760 \text{ hr} = 0.000055$
- $P_3 = 0.01 \text{ failures} \times 16 \text{ hr} / 8760 \text{ hr} = 0.0000182$
- $P_4 = 0.012 \text{ failures} \times 80 \text{ hr} / 8760 \text{ hr} = 0.0001095$

Now let's create a reliability analysis diagram for a power system shown in Fig. 4, considering how a failure of each element will affect the power supply for 13 kV bus 5. Obviously, if any one of 230 kV lines fails, relay protection will trip the corresponding breaker, and 13 kV bus will be fed through 230 kV bus and 230/13 kV transformer from 230 kV line remaining in service. So, 230 kV line elements (1) should be connected in parallel as far as 13 kV bus reliability is concerned.

If any of the 230 kV breakers fails, a breaker failure protection will trip another breaker and as a result, both 230 kV lines will be disconnected, and 13 kV bus will be deenergized. So, the 230 kV breaker elements (2) should be connected in series. The

same logic applies to 230 kV bus and 230/13 kV transformer elements; failure of each of them will lead to 13 kV bus losing power supply. Therefore, elements 3 and 4 should be connected in series as well. Based on the performed analysis, the overall reliability diagram may be drawn as follows:

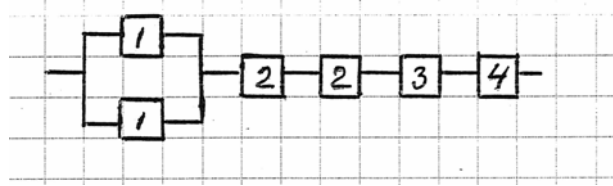

Fig. 5. Reliability Analysis Diagram

Now, using equations for reliability of systems consisting of elements connected in series and parallel, the overall probability  $p_5$  of the 13 kV bus losing power supply may be found as follows:

$$\begin{aligned} P_5 &= P_1 \times P_1 + P_2 + P_2 + P_3 + P_4 \\ &= 0.00171 \times 0.00171 + 0.000055 + 0.000055 + 0.0000182 + 0.0001095 \\ &= 0.00024 \end{aligned} \quad (2)$$

And finally, an expected downtime per year  $D_f$  for the 13 kV bus 5 is:

$$D_f = P_5 \times 8760 \text{ hr} = 0.00024 \times 8760 \text{ hr} = 2.11 \text{ hr}, \quad (3)$$

Which means that during every calendar year the 13 kV bus is expected to be out of service 2.11 hours on average. This value seems to be small enough not to require any further actions, but it is still useful to discuss how reliability of a power system may be increased. One of the options is to provide a back-up for one of the system single elements. To see what effect it may have on the downtime of the 13 kV bus in our previous example, let's assume that we added another 230/13 kV transformer (element 6) to serve as an independent back-up for transformer 4. From the previous example, the probability of transformer 6 being unavailable is:

$$P_6 = P_4 = 0.0001095$$

Keeping in mind that now if one of the transformers fails and the second one is still going to feed the 13 kV bus, equation (2) for probability of this bus being out of service may be rewritten as follows:

$$\begin{aligned} P_5 &= P_1 \times P_1 + P_2 + P_2 + P_3 + P_4 \times P_6 \\ &= 0.00171 \times 0.00171 + 0.000055 + 0.000055 + 0.0000182 + 0.0001095 \times 0.0001095 \\ &= 0.0001311 \end{aligned}$$

Accordingly, equation (3) for the expected downtime of 13 kV bus in any given year will be as follows:

$$D_f = P_5 \times 8760 \text{ hr} = 0.0001311 \times 8760 = 1.15 \text{ hr}$$

So,  $D_f$  was reduced by a little more than 1 hr, and financial analysis should define if this improvement in reliability of customer power supply is worth the investment on the additional transformer.

Another way to improve reliability of a power system is to upgrade the substation switching system. With that said, let's familiarize ourselves with the different types of the substation switchyard arrangement presently used by utility companies and compare their advantages and disadvantages.

## Typical Substation Switching Systems

Let's start our review of substation switching systems with the simplest one called "Single Straight Bus System" shown in Fig. 6.

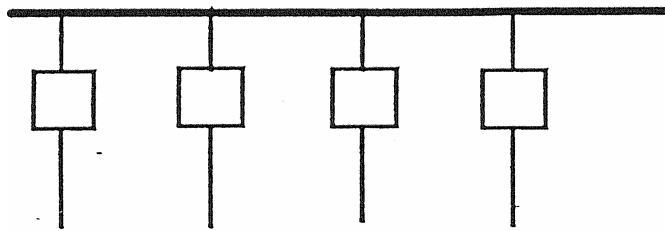

Fig. 6. "Single Straight Bus System"

This bus arrangement has the following advantages:

- Lowest cost
- Simplicity
- Easily expandable
- Small land area required

However, there are the following disadvantages as well associated with this system:

- Lowest reliability out of all switching systems
- Bus of breaker fault causes loss of the entire station
- Breaker removal for maintenance causes loss of corresponding line

Because of these deficiencies, single straight bus switching systems are rarely used for modern new substations. However, substations built more than 20 years ago still often have them. Even today, depending on how the whole system with interconnections between substations is arranged, straight bus may be considered for a specific substation if reliability of the whole grid is acceptable.

The next substation bus arrangement that we want to consider is a "Single Sectionalized Bus System", shown in Fig. 7, which provides a little bit more reliability and flexibility than just a straight bus without a sectionalizing breaker.

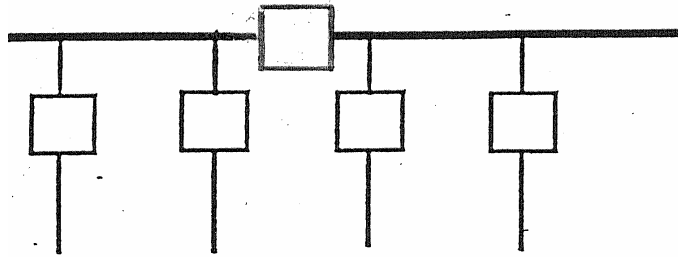

Fig. 7. Single Sectionalized Bus System

As we discussed in the Part 1 of this course, the main benefit of sectionalization of power systems is a reduction of customer outages associated with the the fault on the line, transformer, etc. This is exactly the case here. Comparing systems shown in Fig. 6 and 7, we can clearly see that if for a bus without a section breaker, a failure of any line breaker on the bus will lead to the outage of the whole station; whereas, for a bus with a section breaker, this type of fault will lead to the outage of only half of the station. The only situation when the whole station will be switched off is when a bus section breaker fails.

Let's summarize pros and cons for a single sectionalized bus system:

- Advantages:
  - Low cost
  - Simplicity
  - Easily expandable
  - Small land area required
  - Higher reliability than single bus system
- Disadvantages:
  - Additional breaker required
  - Sectionalizing breaker fault causes loss of the entire station
  - Breaker removal for maintenance causes loss of corresponding line

The next bus system to consider is a “Transfer Bus System”, shown in Fig. 8, which besides the main bus has a transfer bus connected to it through a transfer breaker.

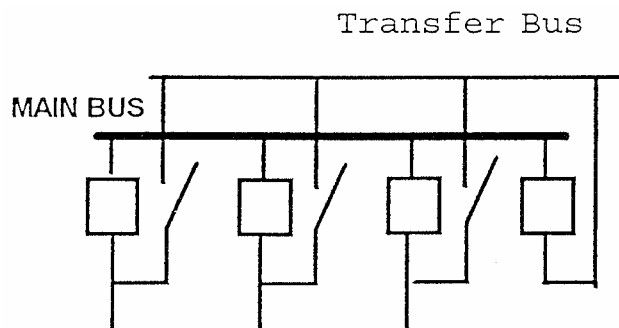

Fig. 8. Transfer Bus System

Compared with both previously discussed single straight bus options, a transfer bus system provides more operational flexibility because it allows taking any line circuit breaker out of service while leaving the corresponding line energized. As you can see from Fig. 8, after line breaker is disconnected on both sides (for simplicity purposes breaker disconnecting switches are not shown), the transfer disconnect will get closed and the transfer breaker will temporary protect the line whose permanent breaker is taken out of service. While representing a slight improvement from operational standpoint compared with single bus systems, a transfer bus arrangement has even lower reliability than a sectionalized bus, because as it was the case for a bus without a section breaker shown in Fig. 6, a failure of any breaker in a transfer bus system will lead to an outage of the whole substation.

Let's summarize advantages and disadvantages for a transfer bus system:

- Advantages:
  - Reasonable cost
  - Fairly small land area required
  - Any line stays in service during breaker maintenance
- Disadvantages:
  - Additional breaker is required
  - Any breaker or main bus fault causes loss of the entire station

Because of low reliability, all of the above mentioned switching systems lost their former popularity and are rarely used at modern substations. One of the more reliable and widely used bus arrangements is a ring bus system, shown in Fig. 9, which has two breakers associated with each outgoing circuit. Fault on any circuit will lead to both associated breakers tripping and breaking a ring which is acceptable.

If any of the breakers fail, the adjacent breakers will trip and two circuits will be taken out of service, not the whole station, as it was the case for a straight bus without section breaker and a transfer bus system. If we need to take any breaker out of service for maintenance or repair, the circuit will stay energized unlike it was for both single straight busses with or without section breaker, where taking out the line breaker leads to the outage on the line as well.

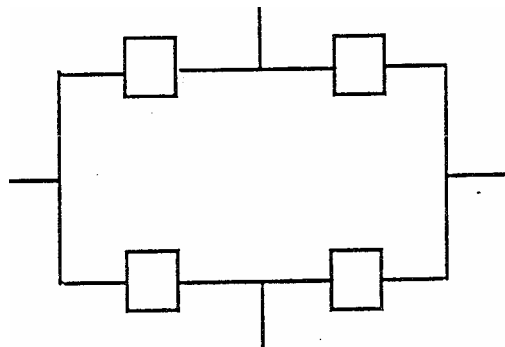

Fig. 9. Ring Bus System



Let's summarize pros and cons for a ring bus system:

- Advantages:
  - Flexible operation
  - High reliability
  - Double feed for each circuit
  - Any breaker may be removed without affecting the service
- Disadvantages:
  - Breakers should have high current rating based on a total load
  - Difficult to arrange
  - Any line fault trips two breakers

If reliability analysis shows that a ring bus is not reliable enough, the next step in increasing redundancy of power supply is application of a “Breaker-and-a-half” system, shown in Fig. 10.

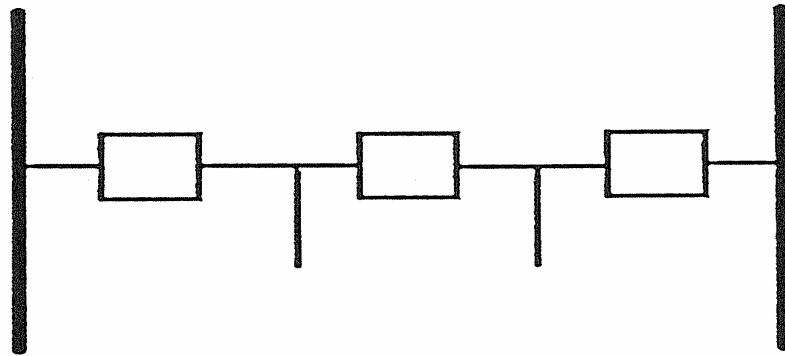

Fig. 10. Breaker-and-a-half Switching System

The strange name for this bus arrangement is based on the fact, that each bay of these switching systems (there is one bay shown in Fig. 10, but usually substation switchyard consists of several bays) has three (3) breakers for two (2) circuits. So, if you want to find formally how many breakers are associated with each circuit, this number will be  $3/2$ , or there are 1.5 breakers per circuit. Unlike it was the case with a ring bus system, where a failure of any breaker leads to taking 2 circuits out of service, for a breaker-and-a-half arrangement, only a failure of a middle breaker in the bay will lead to losing 2 circuits connected on each side of this breaker. For a failure of a breaker connected to any of the tie busses (left or right), only one circuit associated with this breaker will be switched off.

Advantages and disadvantages of a breaker-and-a-half system may be summarized as follows:

- Advantages:
  - Flexible operation
  - High reliability
  - Double feed for each circuit

- Any breaker may be removed without affecting the service
- Tie bus fault doesn't interrupt service to any circuit
- All switching done with circuit breakers
  
- Disadvantages:
  - 1 ½ breakers required per circuit
  - Complicated relaying

Again, if based on reliability analysis we still need a higher redundancy than breaker-and-a-half arrangement is providing, there is one more option left: it is so called “Double bus

– double breaker”, shown in Fig. 11.

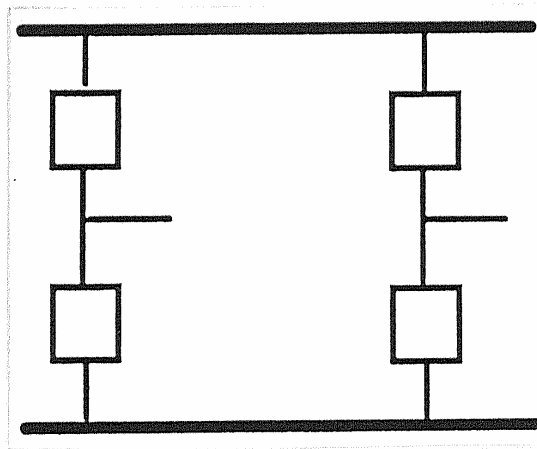

Fig. 11. Double Bus – Double Breaker System

As a step forward reliability wise, with a double bus – double breaker system, a failure of any breaker will never lead to the loss of more than one circuit, while for a breaker-and-a-half a failure of a middle breaker resulted in two circuits being switched off.

Let's summarize pros and cons of a double bus – double breaker switching system:

- Advantages:
  - Flexible operation
  - Very high reliability
  - Double feed for each circuit
  - Any breaker may be removed without affecting the service
  - Bus fault doesn't interrupt service to any circuit
  - All switching done with circuit breakers
  - Only one circuit is lost for breaker failure
  
- Disadvantages:
  - High cost
  - Two breakers required for each circuit

Finalizing our discussion about typical substation switching systems, I wanted to emphasize that selection of any specific bus arrangement needs to be based on financial analysis because any increase in reliability will lead to extra costs, and this investment should be justified before the more reliable switching system is chosen.

## Insulation Coordination

Another important engineering task is to provide proper insulation for all substation elements. Let's start discussing this subject by answering the following basic questions:

- **What is insulation?** Insulation is a dielectric material (not conducting current)
- **Where is insulation required?** For all substation components it is required between:
  - Energized parts of different phases and/or circuits
  - Energized parts and the ground
- **What is required from insulation?** It should withstand without failure any voltage level in the system it is designed for.

For any system voltage, there is a certain standardized parameter called BIL (Basic Insulation Level) which defines if insulation is adequate. BIL is a specific insulation level expressed in kilovolts of the peak value of a standard lightning impulse, which insulation should withstand. For consistency purposes, it is accepted that this standard impulse reaches the peak value of voltage in 1.2  $\mu$ s and drops to the 0.5 of peak value in 50  $\mu$ s. There are specific BIL values required for each voltage system. For example, for the 26 kV system, a required BIL is 200 kV; for 138 kV, it is 650 kV; and for 230 kV it is 900 kV.

BIL requirement has a very significant impact on substation design because it introduces the required minimum phase-to-phase and phase-to-ground clearances. For example, for a 138 kV system (650 kV BIL), a minimum phase-to-phase clearance is 62" and phase-to-ground is 50".

Insulation of substation equipment should be coordinated to ensure that elements (for example, surge arresters) which are supposed to protect other equipment (for example, transformers) will fail first diverting overvoltage into the ground grid. This principle is illustrated in Fig. 12, where Curve B corresponds to impulse strength of the equipment insulation, and curves A & C represent characteristics of protective devices (surge arresters). As we can see, a withstand voltage of device A is higher than the one for B, but a withstand voltage of device C is lower than the one for B. From these facts, we may conclude that device C will protect the equipment, but device A will not.

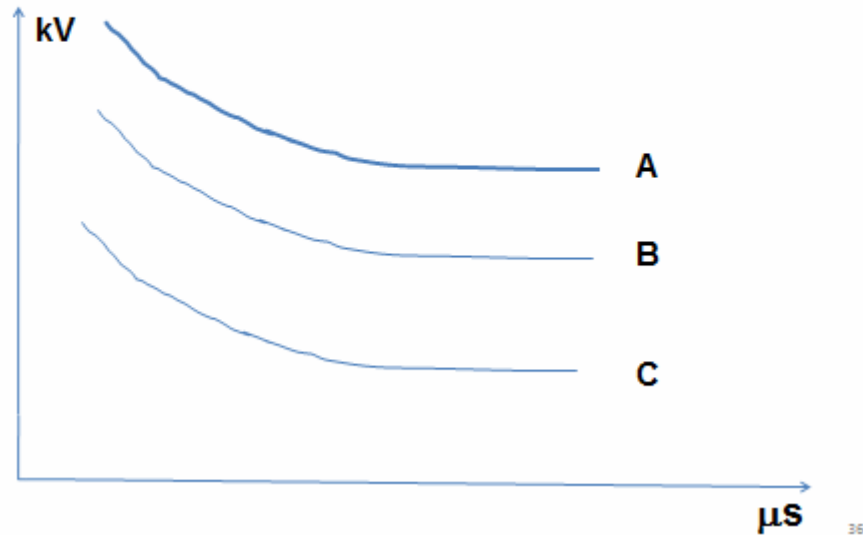

Fig. 12. Insulation Coordination

## Substation Safety and Fire Protection

Another extremely important substation engineering aspect is associated with safety and fire protection. It is fair to say that safety is always a No. 1 priority in substation design, operation and maintenance. Unlike the case where a higher reliability required a larger investment, we can't put a price tag on safety since there is no such thing like working conditions being more or less safe. It should always be 100% safe to work at or visit the substation. There are numerous laws, rules, codes, etc. governing safety requirements; of the most important being "IEEE Standard C2-2012. 2012 National Electrical Safety Code®" (NESC®) [1]. The main mission of all these regulations is safeguarding of personnel from hazards arising from the installation, maintenance or operation of substation equipment. Safety standards contain requirements for:

- Enclosure of electrical equipment
- Rooms and spaces
- Illumination
- Floors, floor openings, passageways, stairs
- Exits
- Installation of equipment:
  - Protective grounding
  - Guarding live parts
  - Working space above electrical equipment
- Specific rules for installation of all typical substation equipment

All these measures are based on common sense and the goal to provide a safe environment for substation personnel. The following requirements may be mentioned as an example:

1. Enough clearance from energized parts should be provided to avoid accidental contact with them. If that can't be met, live parts should be guarded or enclosed.
2. A minimum height from the ground to any ungrounded part of an electrical installation should be 8'-6", so a person staying on the ground can't touch a substation element or its part which may become energized accidentally. For example, the bottom of a post insulator supporting an energized bus does not normally have any potential. However, if bus flashover to the ground over insulator occurs, touching the bottom of the insulator may become unsafe. That's why an 8'-6" distance from the bottom of insulator to the ground should be provided.
3. There should be sufficient illumination for personnel to clearly see their surroundings and perform any work safely. Required illumination levels are specified in NESC® [1].
4. All passageways and stairs should be wide enough for personnel to navigate them safely, adequate railing should be provided, and floor openings should have guard rails.
5. Exits should be clearly marked and evacuation routes should be free from obstructions. Depending on the function of the building (for example, control house), it may require several exits to avoid personnel being trapped during equipment fault, fire, etc.
6. All substation metallic structures, fences, and equipment tanks should be connected to a station ground grid which should be designed to ensure that step and touch potential values are lower than the ones stipulated in the applicable standards.

Another important topic related to safety is substation fire protection whose mission is to protect substation personnel, equipment and buildings from fire and prevent fire from spreading. As it was with safety, there are numerous guides and standards for substation fire protection.

The following means of fire protection are used:

- Separation of equipment
- Installation of protective fire walls
- Deluge systems
- Application of fire retardant materials for substation buildings
- Fire alarm system
- Installation of oil retention pits for oil containing equipment

- Appropriate substation design to prevent fire from spreading from one part of the station to another; for example, avoidance of uneven substation surface profile

The example of a fire wall protecting different substation components from fire is shown in Fig. 13.



Fig. 13. 138 kV Cable Oil Pump House with a Fire Wall

### **Substation Design Issues**

Building a new substation or retrofitting the old one is a complex process full of design and engineering tasks to be worked on. The main steps in Substation Design and Engineering are as follows:

- Selection of a substation switching system: ring bus, breaker-and-a-half, etc. based on reliability requirements
- Preparation of a key plan which should show the location of all components of a substation and their interconnections, as well as steel structures, control house, fire walls, driveways, fence and property line
- Selection and ordering of equipment, which is usually done in a utility company by a designated group of equipment experts who specify transformers, breakers, etc., request bids from approved vendors, evaluate the bids, place the order with a winning bidder, and participate in testing and commissioning of equipment
- Engineering support for licensing and permitting which includes preparation of necessary drawings sealed by Professional Engineers, testifying at public hearings at the municipalities where a new substation is planned to be built, ordering of noise studies and selecting means of noise mitigation if needed

- Civil and Structural design which includes:
  - pile design
  - foundations
  - steel structures
  - control house
  
- Electrical layout design which includes:
  - Positioning of equipment
  - Bus design
  - Design of manhole and conduit system
  - Design of auxiliary A.C. power system
  - Selection of D.C. batteries and battery chargers
  - Layout of control house
  - Grounding and lightning protection design
  
- Control design which includes:
  - Relay protection and instrumentation system schematics and wiring diagrams
  - Relay racks or panels
  - Remote control and metering (SCADA – system control and data acquisition)
  
- Construction support which includes a resolution of technical problems discovered during construction, ordering of additional materials, etc.

Because selection of equipment is one of the most critical tasks in substation engineering, let's discuss this process in a greater detail, starting with the following examples of major equipment ratings:

- Power transformer ratings:
  - Capacity including overload capability
  - Cooling class
  - Frequency
  - Primary and secondary voltage
  - Phase relation between primary and secondary voltages
  - BIL for both high and low voltage sides
  - Voltage regulation requirements: load and no-load taps
  - Transformer impedance
  - Sound level
  
- Circuit breaker ratings:
  - Rated maximum voltage
  - Rated continuous current
  - BIL
  - Rated short circuit current
  - Interrupting time
  - Rated frequency

- Current transformer (CT) ratings:
  - BIL
  - Rated current
  - Rated frequency
  - Number of taps and ratio for each tap
  - Accuracy class
  - Type (bushing CT, free standing, etc.)

To better understand a process of equipment selection, let's discuss an example of choosing 138 kV Line #3 Circuit Breaker, shown in Fig. 14, assuming that the following information about the system is available:

- Continuous current for all the lines:
  - Line #1 – 1,000 A,
  - Line #2 – 1,500 A,
  - Line #3 – 800A
- 3-phase fault current on the bus is 46.5 kA, contributions from the lines:
  - Line #1 – 24.5 kA,
  - Line #2 – 12 kA,
  - Line #3 – 10 kA
- Projected Substation load growth is 25%
- Available breaker ratings:
  - Continuous current: 1,200 A, 2,000 A, 3,000 A
  - Short circuit interrupting capability: 40 kA, 50 kA

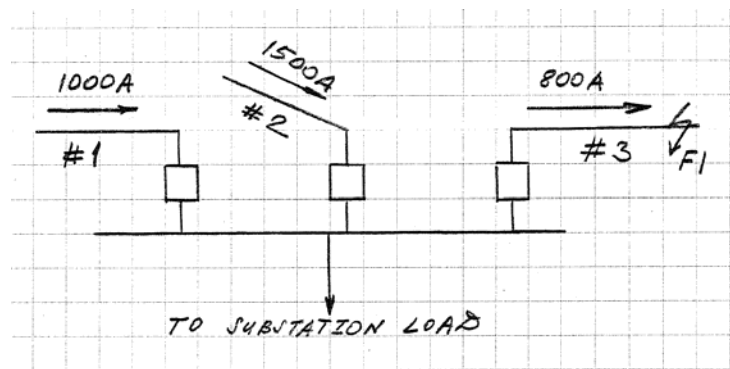

Fig .14. Power System for Example of 138 kV Breaker Selection

Solution:

1. Future load considering 25% growth:  
 $(1000 \text{ A} + 1500 \text{ A} - 800 \text{ A}) \times 1.25 = 2,125\text{A}.$



2. This load may be fed from Line #3 through its circuit breaker if lines #1 and #2 are switched off. So, the breaker should be sized to carry at least 2,125 A. Closest available continuous rating meeting this requirement is 3,000 A.
3. Maximum 3-phase fault current that Line #3 breaker needs to interrupt may be calculated by deducting from a total bus fault current a contribution from line #3, i.e.  $46.5 - 10 = 36.5\text{kA}$
4. Closest short circuit current interrupting rating and meeting requirement to be at least 36.5 kA is 40 kA
5. This is a summary of the selected circuit breaker ratings:
  - 5.1. Rated maximum voltage – 138 kV
  - 5.2. Rated continuous current – 3,000 A
  - 5.3. BIL – 650 kV
  - 5.4. Rated short circuit current – 40 kA

As you can see, selection of equipment for a specific application requires an input data which may be obtained from system studies. Such data include power flows, load projection, short circuit current calculations, etc., which are usually performed by utility company planners.

### **Substation Insulator's Performance Improvement**

As we discussed before, insulation needs to be provided between energized parts and the ground as well as between phases of the same circuit or different circuits. One of the substation components providing a required insulation between energized conductors and grounded structures are Substation Insulators whose main types are as follows:

- Station post insulators
- Equipment (transformer, breaker) bushings
- Equipment (CCVT, surge arrester, etc.) insulating columns

Insulator materials are either porcelain or polymer. For each insulator, there are numerous electrical and mechanical properties specified, which are used by substation designers and engineers in their calculations. Typical porcelain station post insulator is shown in Fig. 15.

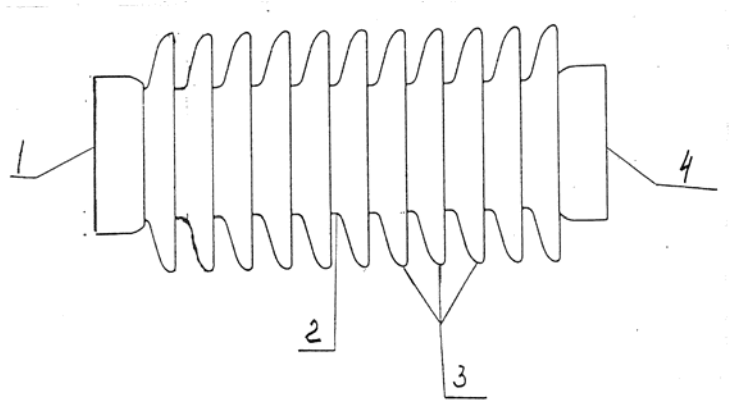

1 – Cap; 2 – Porcelain body; 3 – Skirts (Pettycoats); 4 - Base

Fig. 15. Station Post Insulator

Substation design is based on the assumption that substation insulators will retain their insulating abilities. In reality, there are numerous factors that may affect insulator performance, thereby making them unsuitable for an intended application.

Let's discuss the most common problems related to substation insulators and possible ways to resolve them.

One of these problems is icing which represents a build-up of ice along the surface of the insulators, thereby bridging pettycoats and resulting in flashovers along the surface of the insulators and in equipment damage. Icing may be prevented by the following measures:

- Insulator surface coating (usually silicon) which prevents ice buildup
- Application of “high creep” insulators with longer than standard skirts which prevents ice bridging
- Installation of creepage extenders which are mostly used on existing insulators after it was discovered that they are susceptible to icing. Post insulators with extenders are shown in Fig. 16
- Application of RGI (resistance graded insulators) which have a conductive coating, providing a path for leakage currents and warming a surface of insulator body, thereby preventing icing



Fig. 16. 138 kV Post Insulators with Creepage Extenders

The next problem with insulators frequently encountered by substation maintenance personnel is pollution which represents a deposit of pollutants (salt, dust, ashes, etc.) on the surface of insulators, resulting in flashovers, tracking along the surface of insulator and ultimately leading to insulator and equipment damage. The main remedy for pollution is naturally cleaning and washing of insulators, which needs to be done periodically as a part of substation maintenance.

Another serious problem associated with insulator maintenance is prevention of animal contacts with energized substation busses and bare cables. The most common animal intruders are squirrels and raccoons who for some reason are often climbing on substation structures and touching conductors while bypassing the supporting insulators. Usually this problem is associated with distribution voltages up to 26 kV.

The consequences of these encounters are flashovers leading to equipment damage. The following measures may be used to prevent animal contacts:

- Installation of rubber boots, sleeves, etc. over bus connectors
- Insulation of bare conductors using insulating tape, conduits
- Application of insulating paint over metal surfaces: transformer tank, etc.

An example of implementation of these measures is shown in Fig. 17.



Fig. 17. 13/4 kV Transformer 13 kV Bushings and surge arresters with rubber boots

## Conclusion

This part of the course provided an overview of modern substation engineering aspects, concentrating on a detailed description of typical issues and their possible resolution options to enable you to:

- Analyze reliability of power supply systems
- Describe typical substation switching systems, their advantages and disadvantages
- Understand basics of insulation coordination
- Clearly understand the importance of safety in substation design and engineering
- List means of substation fire protection
- Describe steps in substation design and engineering
- Select substation equipment
- Describe how to improve substation insulator's performance

## References

1. IEEE Standard C2 -2012. 2012 National Electrical Safety Code® (NESC®).